

0CI00-M16500EN

Contents

Fig. No. Fig. Name
728374-51100

Fig. No. Fig. Name

728374-51101

1. FUEL INJECTION PUMP
2. GOVERNOR DRIVING

Fig.1. FUEL INJECTION PUMP

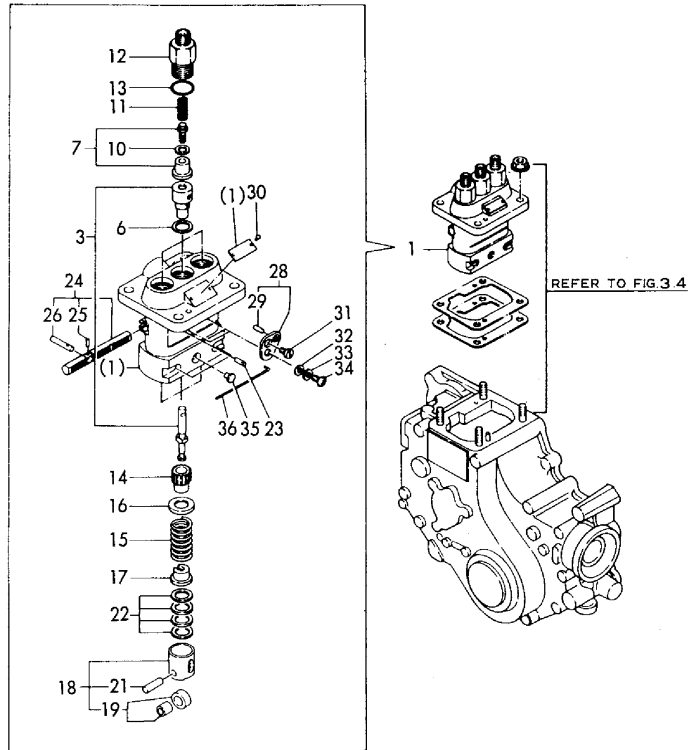

(A)=728374-51100
(B)=728374-51101
(C)=

(D)=
(E)=
(F)=

No.	Lev.	Parts No.	Description	Q'ty						I	R
				(A)	(B)	(C)	(D)	(E)	(F)		
1	1	728374-51100	PUMP ASSY, INJECTION	1							
1-1	1	728374-51101	PUMP ASSY, INJECTION	1	1						N
		(A=E13959)	(C=E00394)	(D=E01583)		(E=E13924)					
3	2	128170-51101	PLUNGER ASSY	3	3						
6	2	124950-51270	GASKET	3	3						
7	2	128170-51300	VALVE ASSY, DELIVERY	3							
7-1	2	105500-51300	VALVE ASSY, DELIVERY		3						N
		(A=E13959)	(C=E00394)	(D=E01583)		(E=E13924)					
10	2	124550-51350	GASKET, DELIVERY	3	3						
11	2	124550-51320	SPRING, DELIVERY	3	3						
12	2	124550-51341	HOLDER, DELIVERY L43	3	3						
13	2	124550-51370	O-RING	3	3						
14	2	124950-51510	PINION	3	3						
15	2	124950-51190	SPRING, PLUNGER	3	3						
16	2	174307-51170	RETAINER, SPRING A	3	3						
17	2	174307-51181	RETAINER, SPRING B	3	3						
18	2	124550-51200	TAPPET	3	3						
19	3	111100-51220	ROLLER, TAPPET	3	3						
21	3	174100-54120	PIN	3	3						
22	2	174307-51700	SHIM SET	3	3						
23	2	103854-51251	PIN, PLUNGER	1	1						
24	2	121450-51500	RACK, CONTROL	1	1						
25	3	121450-51550	PIN	1	1						
26	3	124550-51590	RETAINER	1	1						
28	2	124950-51640	PLATE ASSY, ADJUST	2	2						
29	3	124950-51670	PIN	2	2						
30	2	124220-51890	RIVET	2	2						
31	2	103854-51660	SCREW	2	2						
34	2	26587-050102	SCREW, M5X10	2							
34-1	2	26033-050102	SCREW, M5X10		2						N
		(A=E00394)	(C=E00394)	(D=E01583)		(E=E13924)					
35	2	124950-51450	PIECE, GUIDE	3	3						
36	2	121150-51460	PIN, GUIDE	1	1						

Remarks

(A)=3GM30,3GM30B,3GM30C,3GM30F.
(B)=3GM30VE,3GM30FVE.

Fig.2. GOVERNOR DRIVING

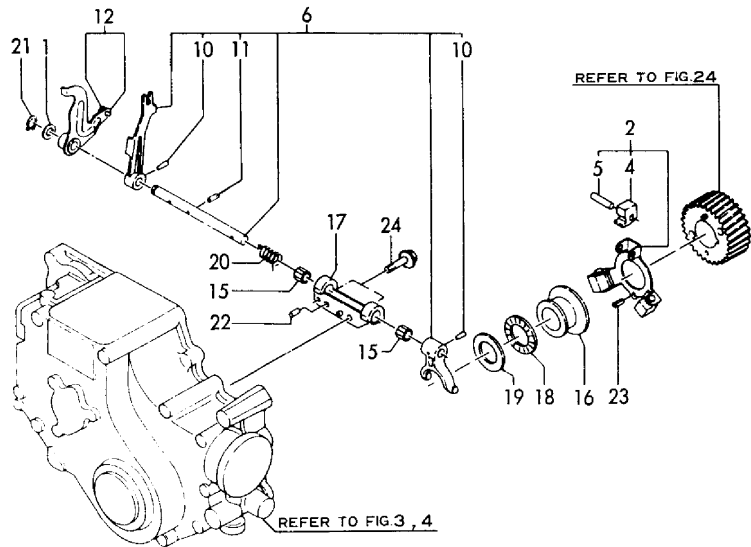

(A)=3GM30
(B)=3GM30VE
(C)=3GM30B

(D)=3GM30C
(E)=3GM30F
(F)=3GM30FVE

No.	Lev.	Parts No.	Description	Q'ty						I	R
				(A)	(B)	(C)	(D)	(E)	(F)		
1	1	104211-42130	PIECE, DISTANCE	1	1	1	1	1	1		
2	1	171016-61100	WEIGHT, GOVERNOR	1		1	1	1			
2-1	1	771016-61620	WEIGHT ASSY,GOVERNOR	1	1	1	1	1	1	1	N
4	2	104200-61200	WEIGHT, GOVERNOR	3	3	3	3	3	3		
5	2	121575-61220	PIN, GOVERNOR WEIGHT	3	3	3	3	3	3		
6	1	721500-61560	LEVER ASSY, GOVERNOR	1	1	1	1	1	1		
10	2	22322-030200	PIN, TAPER 3X20	2	2	2	2	2	2		
11	2	22351-030012	PIN, SPRING 3.0X12	1	1	1	1	1	1		
12	1	121575-61160	LEVER ASSY, CONTROL	1		1	1	1			
12-1	1	121575-61161	LEVER ASSY, CONTROL	1	1	1	1	1	1	1	N
15	1	122410-61650	BEARING, FJ-1010W	2	2	2	2	2	2		
16	1	121000-61600	SLEEVE, GOVERNOR	1	1	1	1	1	1		
17	1	121575-61620	SUPPORT	1	1	1	1	1	1		
18	1	121575-61710	BEARING, FNTA-2542	1	1	1	1	1	1		
19	1	121575-61720	COLLAR	1	1	1	1	1	1		
20	1	121575-66310	SPRING, STARTING	1	1	1	1	1	1		
21	1	22242-000100	RING, 10	1	1	1	1	1	1		
22	1	22312-040080	PIN, PARALLEL M4X 8	2	2	2	2	2	2		
23	1	22351-040008	PIN, SPRING 4.0X 8	2	2	2	2	2	2		
24	1	26106-060282	BOLT, M6X 28 PLATED	2	2	2	2	2	2		

Parts No. Index

Parts No.	Fig. No.	Ref. No.
103854-51251	1	23
103854-51660	1	31
104200-61200	2	4
104211-42130	2	1
105500-51300	1	7 -1
111100-51220	1	19
121000-61600	2	16
121150-51460	1	36
121450-51500	1	24
121450-51550	1	25
121575-61160	2	12
121575-61161	2	12 -1
121575-61220	2	5
121575-61620	2	17
121575-61710	2	18
121575-61720	2	19
121575-66310	2	20
122410-61650	2	15
124220-51890	1	30
124550-51200	1	18
124550-51320	1	11
124550-51341	1	12
124550-51350	1	10
124550-51370	1	13
124550-51590	1	26
124950-51190	1	15
124950-51270	1	6
124950-51450	1	35
124950-51510	1	14
124950-51640	1	28
124950-51670	1	29
128170-51101	1	3
128170-51300	1	7
171016-61100	2	2
174100-54120	1	21
174307-51170	1	16
174307-51181	1	17
174307-51700	1	22
22242-000100	2	21
22312-040080	2	22
22322-030200	2	10
22351-030012	2	11
22351-040008	2	23
26033-050102	1	34 -1
26106-060282	2	24
26587-050102	1	34
721500-61560	2	6
728374-51100	1	1
728374-51101	1	1 -1
771016-61620	2	2 -1

Parts No.	Fig. No.	Ref. No.
-----------	----------	----------

Parts No.	Fig. No.	Ref. No.
-----------	----------	----------

Parts No.	Fig. No.	Ref. No.
-----------	----------	----------